

Installazione slim

foro incasso:
435x495 R10 mm
base 500 mm

*Flat-mounted installation
built-in fitting hole:
435x495 R10 mm
cabinet 500 mm*

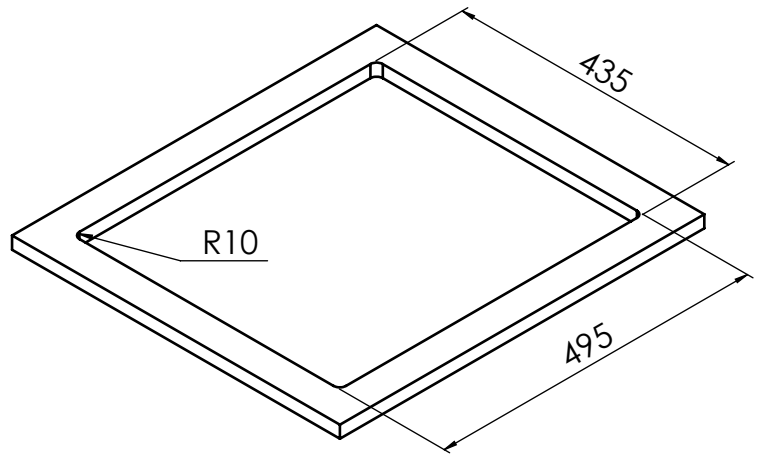

Installazione filotop

foro incasso: 435x495 R10 mm
abbassamento filotop:
451x511x1,5 R11 mm
base 500 mm

*Flush installation
built-in fitting hole:
435x495 R10 mm
filotop lowering:
451x511x1,5 R11 mm
cabinet 500 mm*

