

Installazione slim

foro incasso:
485x495 R10 mm
base 600 mm

*Flat-mounted installation
built-in fitting hole:
485x495 R10 mm
cabinet 600 mm*

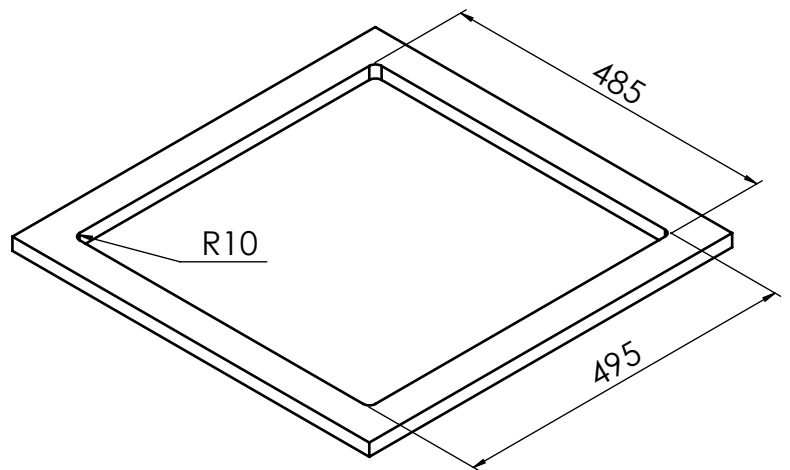

Installazione filotop

foro incasso: 485x495 R10 mm
abbassamento filotop:
501x511x1,5 R11 mm
base 600 mm

*Flush installation
built-in fitting hole:
485x495 R10 mm
filotop lowering:
501x511x1,5 R11 mm
cabinet 600 mm*

