

Installazione slim

foro incasso:
740x495 R10 mm
base 800 mm

*Flat-mounted installation
built-in fitting hole:
740x495 R10 mm
cabinet 800 mm*

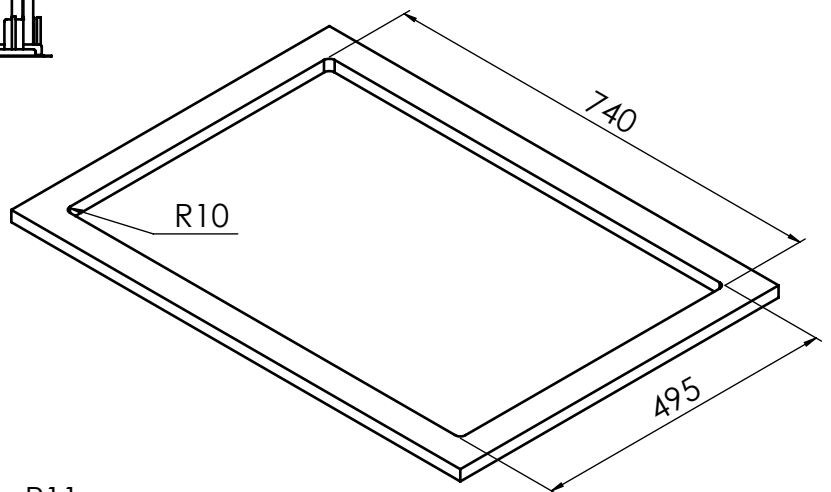

Installazione filotop

foro incasso: 740x495 R10 mm
abbassamento filotop:
756x511x1,5 R11 mm
base 800 mm

*Flush installation
built-in fitting hole:
740x495 R10 mm
filotop lowering:
756x511x1,5 R11 mm
cabinet 800 mm*

